

Bowl capacity Capacità vasca	Speed Velocità	Power Potenza	Voltage Voltaggio	Dimensions Dimensioni				Weight Peso
L	RPM	KW	V	mm				kg
				A	B	C	D	

K130	130	75-280	6	400/50/3	2050	1350	975	1370	770
-------------	-----	--------	---	----------	------	------	-----	------	-----

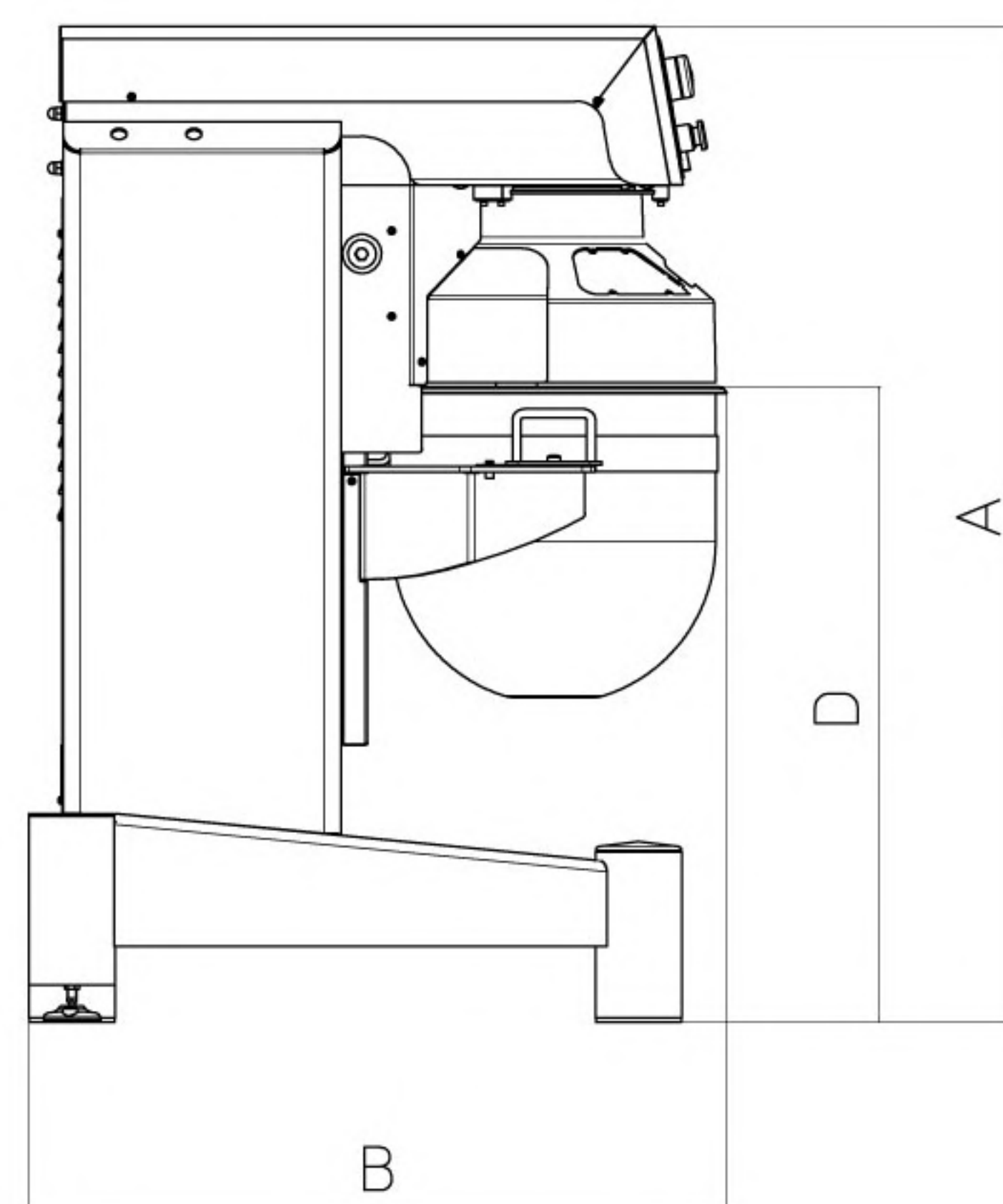

STANDARD

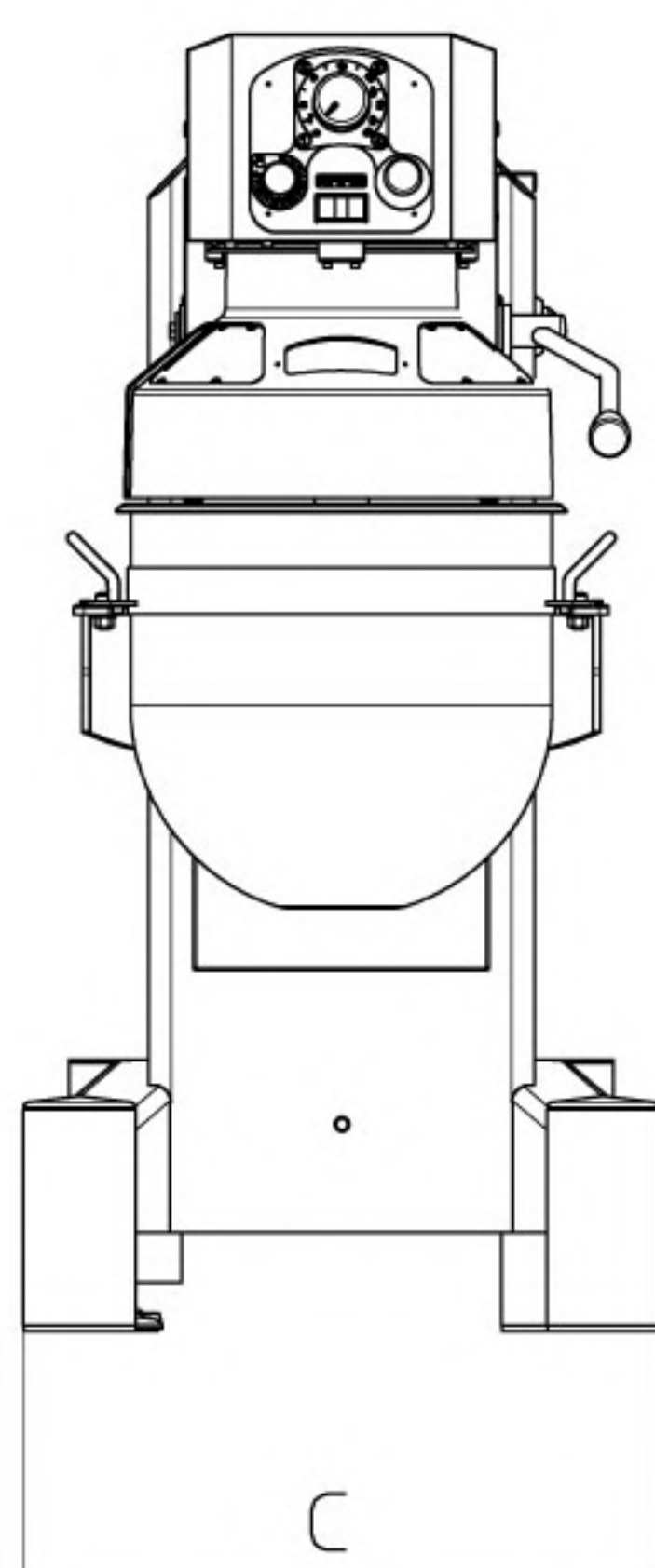
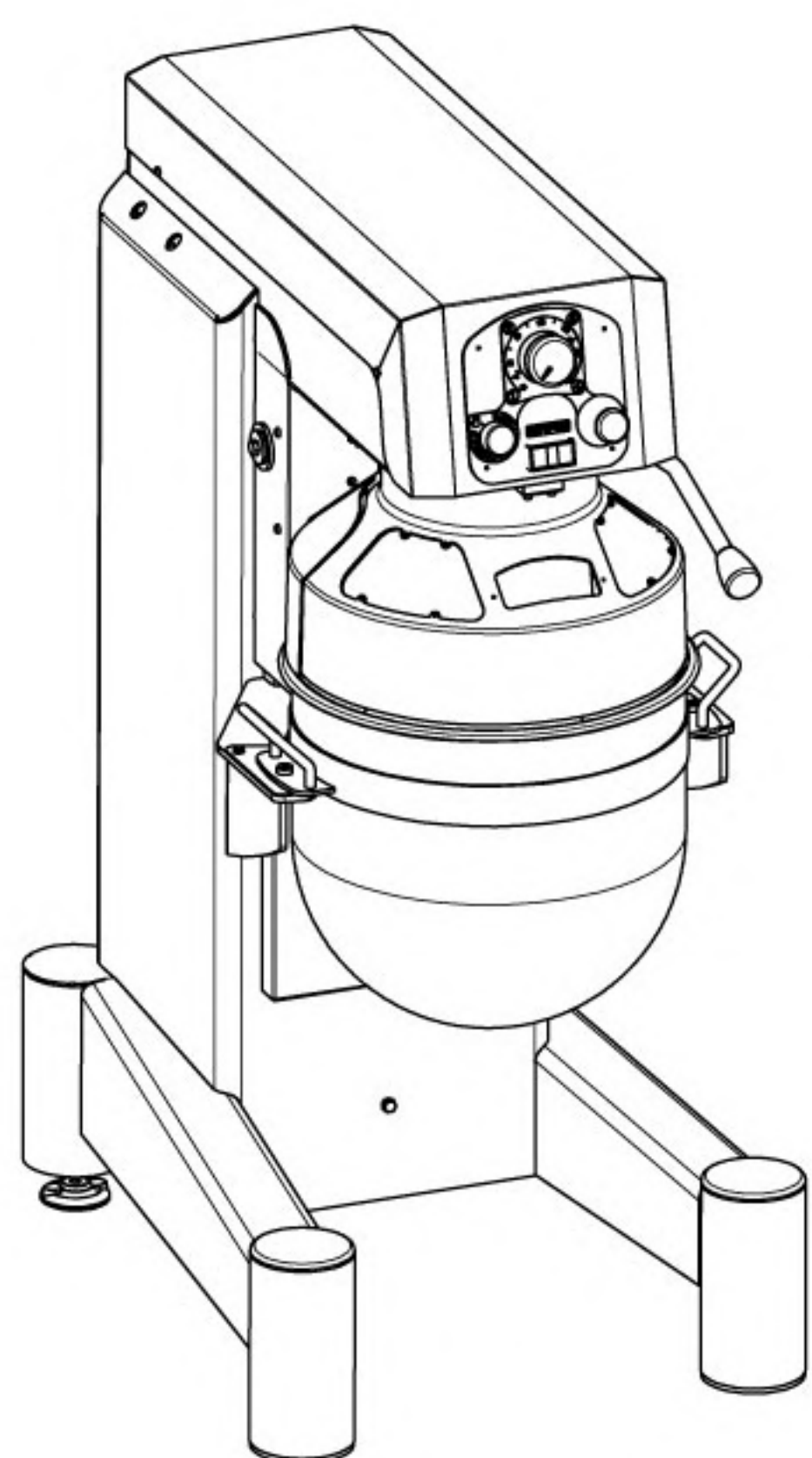

Whisk
Frusta
Fouet
Batidor
Венчик



Spatula
Spatola
Spatule
Espatula
Лопатка



Spiral
Spirale
Spiral
Espiral
Спираль

OPTIONAL



Scraper
Raschiatore
Racleur
Rascador
Скребок