

BLADE LINE

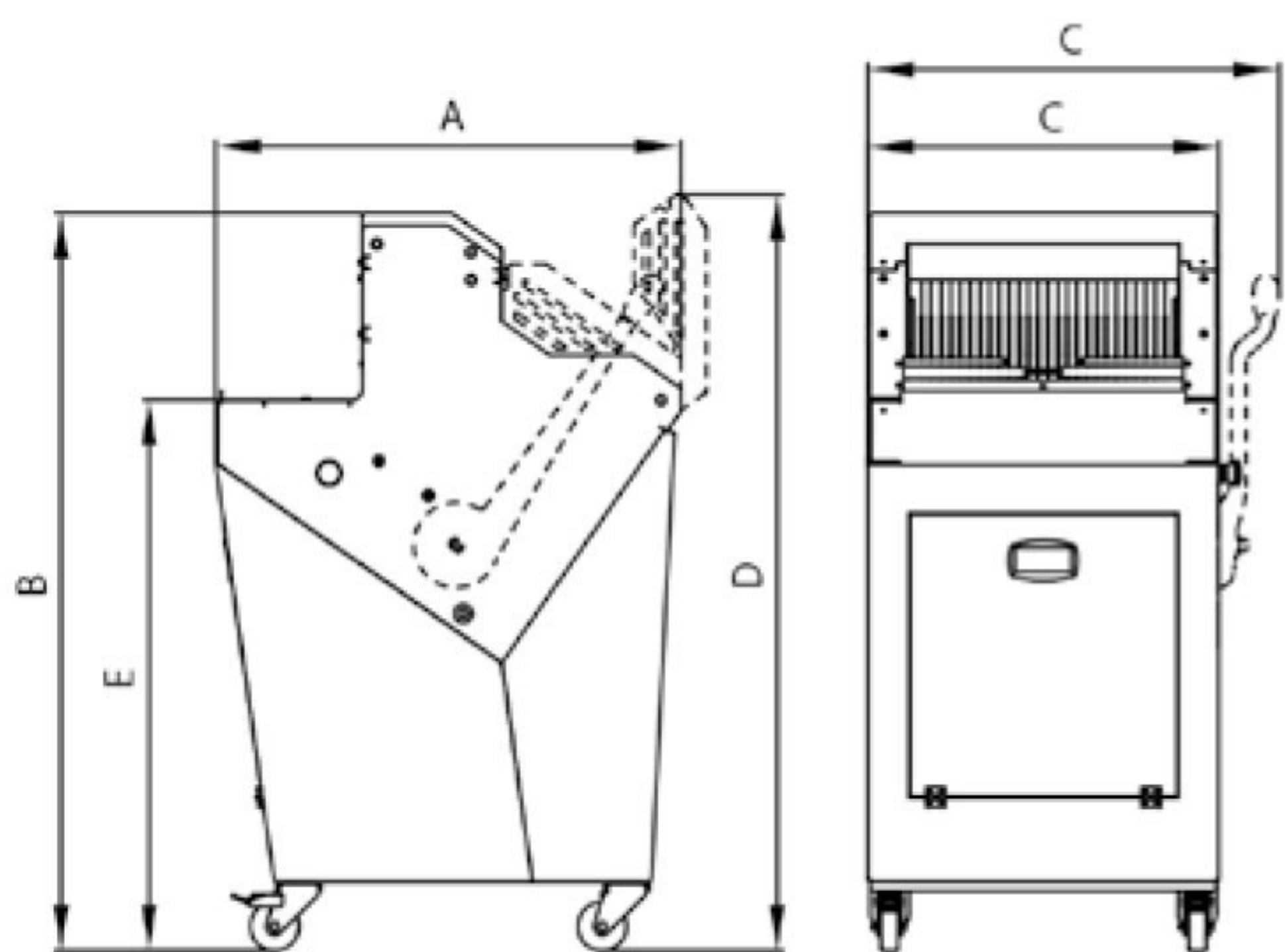

BA530H	520	60-160	9-10-11-12-13-14-15-16-18	0,75	400/50/3	770	1210	660	1250	900	160
---------------	-----	--------	---------------------------	------	----------	-----	------	-----	------	-----	-----

Max cut width Larghezza taglio	Max cut height Altezza taglio	Blade pitch Passo lame	Power Potenza	Volt Volt	Dimensions Dimensioni					Weight Peso
mm	mm	mm	KW	V	mm					kg
					A	B	C	D	E	